

1E4045DA | DART Round Maxi TW

Professional adjustable LED projector

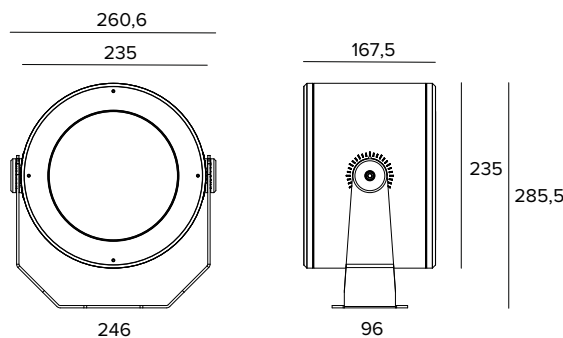

The fixture's photometric values can be found on the following pages



The figures on the drawing are expressed in mm.

SOURCE

Tunable White light module made of high power and high efficiency Ra80 LED sources. Color temperature adjustment range between 2700K and 5000K.

Energy efficiency class: F

Nominal power: 28W

Nominal flux: See photometries

Colour rendering index: 80

Rf: 83

Rg: 97

CCT nominal: See photometries

Lifetime (L80/B10): >50000h tq +25°C

ILLUMINOTECHNICAL CHARACTERISTICS

Equipped with precision methacrylate lenses and spreader filter.

Optic: LENSES

Beam angles: MWFL

Optical efficiency: 63%

Fixture flux: See photometries

Luminous efficacy: See photometries

Photobiological safety: Compliant with RG1 low risk group

MECHANICAL CHARACTERISTICS

Painted die-cast anodised aluminium body and painted stainless steel mounting bracket. Tempered extra clear front glass.

Colour and finish: Ferrite

Weight: 6.6Kg

Degree of protection: IP66

Mechanical Resistance: IK10

ELECTRICAL CHARACTERISTICS

DALI DT8 driver integrated in the body of the fixture. All versions are precabled with a 1.5m long feeding cable H07RN-F. Luminaire compliant with EN 60598-2-22 for power supply from a centralised emergency system CPSS (Central Power Supply System), not incorporated in the luminaire - high risk areas excluded. The default power and flux are 100% in AC and 100% in DC.

Fixture Power: 33W

Power supply: 220-240Vac 50/60Hz

Insulation Class: CLASS 1

Type of driver / Control: DALI DT8

Driver included: YES

SAFE FLICKER: PstLM=<1 and SVM=<0.4 (IEC TR 61547-1 and IEC TR 63158), to ensure a more comfortable and safe light

Ambient temperature: -25°C / +35°C

INSTALLATION

Mounting bracket with aiming adjustability. Adjustable up to $\pm 45^\circ$ on the horizontal pane and $+90^\circ/-45^\circ$ on the vertical plane.

NOTES

Casambi control system available using a dedicated accessory (only for DALI version products). Uses the "Waterblock Smart" technical solution that involves resin coating the connection cables, limiting the risk of humidity reaching the driver or the fixture. It is possible to subject the product to Cataphoresis treatment on request. 110-277Vac version available on request. Commissioning of the control system via free APP; the intervention of a specialist technician can be quoted on request.

WARRANTY

5 years.

WARNING

Luminaire designed for disposal/recycling at end-of-life. Replaceable (LED only) light source by a professional. Replaceable control gear by a professional.

Due to the technological evolution of the electronic components, the data provided may be updated, and as such, confirmation must be requested during the order process.

Luminous flux and power supply have +/-10% tolerances with respect to the indicated value. tq +25°C (CIE 121).

We reserve the right to make technical changes.

Targetti Sankey S.r.l.
Via Pratese, 164
50145 Firenze - Italy
Tel: +39 055 37911
targetti.com
targetti@targetti.com

CCIAA Firenze
Share Capital:
€ 500.000,00
VAT N. (IT):
01537660480
R.E.A: FI-275656

TARGETTI

1E4045DA | DART Round Maxi TW

Professional adjustable LED projector

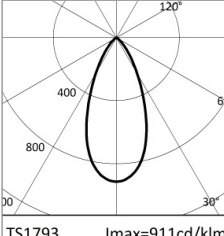
		5000K		H(m)	D(m)	Emax(lx)
		Ra80		46°		
Fixture Power	33W	1	0.84	3138		
Source Flux	3443lm	2	1.69	784		
Fixture Flux	2182lm	3	2.53	349		
Efficacy	66lm/W	4	3.38	196		
TS1793	I _{max} =911cd/klm	I _{max}	3138cd	5	4.22	126

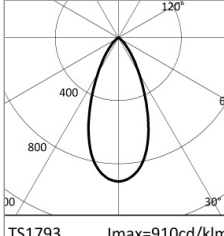
		3800K		H(m)	D(m)	Emax(lx)
		Ra80		46°		
Fixture Power	33W	1	0.84	3263		
Source Flux	3586lm	2	1.69	816		
Fixture Flux	2266lm	3	2.53	363		
Efficacy	68lm/W	4	3.37	204		
TS1793	I _{max} =910cd/klm	I _{max}	3263cd	5	4.22	131

CW

CCT nominal	5000K
Nominal flux	3443lm
Fixture flux	2182lm
Luminous efficacy	66lm/W

NW

CCT nominal	3800K
Nominal flux	3586lm
Fixture flux	2266lm
Luminous efficacy	68lm/W

		2700K		H(m)	D(m)	Emax(lx)
		Ra80		46°		
Fixture Power	33W	1	0.84	2805		
Source Flux	3075lm	2	1.68	701		
Fixture Flux	1945lm	3	2.53	312		
Efficacy	59lm/W	4	3.37	175		
TS1793	I _{max} =912cd/klm	I _{max}	2805cd	5	4.21	112

WW

CCT nominal	2700K
Nominal flux	3075lm
Fixture flux	1945lm
Luminous efficacy	59lm/W

Due to the technological evolution of the electronic components, the data provided may be updated, and as such, confirmation must be requested during the order process.
Luminous flux and power supply have +/-10% tolerances with respect to the indicated value. tq +25°C (CIE 121).

We reserve the right to make technical changes.

Targetti Sankey S.r.l.
Via Pratese, 164
50145 Firenze - Italy
Tel: +39 055 37911
targetti.com
targetti@targetti.com

CCIAA Firenze
Share Capital:
€ 500.000,00
VAT N. (IT):
01537660480
R.E.A.: FI-275656

TARGETTI

1E4045DA | DART Round Maxi TW

Professional adjustable LED projector

Accessories

Filter



Colour	Code
	1E4010

Blade of light filter.
PMMA holographic filter for a blade of light effect.
Completed with powder coated aluminum alloy holder ring.

Grid

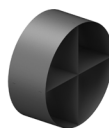

Colour	Code
	1E4013

Anti-glare louver.
Powder coated stainless steel.

Screen



Colour	Code
	1E4011

Asymmetric screen.
Powder coated stainless steel.



Colour	Code
	1E4012

Cylindrical screen.
Powder coated stainless steel.
Short version.

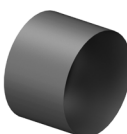

Colour	Code
	1E4059

Cylindrical screen.
Powder coated stainless steel.
Long version.

Mounting System



Colour	Code
	1E3026

Plate for fixture rotation.
Powder coated stainless steel.



Dimensions ØxH mm	Colour	Code
150x352		1E3188

Earthspike.
Powder coated stainless steel.

Due to the technological evolution of the electronic components, the data provided may be updated, and as such, confirmation must be requested during the order process.
Luminous flux and power supply have +/-10% tolerances with respect to the indicated value. tq +25°C (CIE 121).

We reserve the right to make technical changes.

Targetti Sankey S.r.l.
Via Pratese, 164
50145 Firenze - Italy
Tel: +39 055 37911
targetti.com
targetti@targetti.com

CCIAA Firenze
Share Capital:
€ 500.000,00
VAT N. (IT):
01537660480
R.E.A: FI-275656

TARGETTI

1E4045DA | DART Round Maxi TW

Professional adjustable LED projector

Mounting System



Colour Code

● 1E2825

Pole bracket.
Anodised and powder coated aluminium.
Pole Ø 60mm (+/-2mm).



Colour Code

● 1E3097

Pole multiple mounting system.
Powder coated stainless steel.
To be completed with 1E2825.
Max 4 projectors.

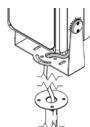

Colour Code

● 1E3187

Pole with base.
Powder coated stainless steel.

Connector



Code

1E2769

Linear connection box IP66/IP68.
5 poles max. wire section 1.5mm².
Cable diameter range from 7 to 12mm.

Tool



Code

1E3305

Tightening wrench for the connector kit.

Control systems



Code

1E3048

IP67 wireless control unit with DALI interface.
It generates a local DALI2 bus, enabling a direct connection to a DALI interface LED driver.
The module can only be used in a closed system and cannot be connected to an existing DALI network.
The module is wireless controlled using a Casambi app for smartphones and tablets using Bluetooth 5.0 technology.
The devices automatically create an adaptive, robust, and reliable wireless mesh network, allowing for the easy and efficient management of a high number of fixtures.
The control unit is preset to the DALI 1CH profile, meaning the device can control a single DALI driver with broadcast commands.
In addition to the DALI broadcast, other operating modes are available, such as:

- Button (normally open)
- Control unit 0/1-10V
- Control unit DALI Tunable White DT8
- Presence sensor



Code

1E4369

IP67 Extender for wireless control of LED driver with dimming DALI interface based on Casambi technology.
It has a DALI2 output with the capacity to control up to 40 lighting fixtures.
With the addition of a further external BUS DALI power supply it is possible to control up to 64 fixtures.
IP67 Extender is preset to the DALI broadcast profile, meaning all the luminaires connected to it are dimmable at the same level.
In addition to the DALI broadcast other operating modes are available, such as:

- EXTENDER DALI 8CH
- EXTENDER DALI Tunable White
- EXTENDER DALI 4CH
- EXTENDER DALI DT8 Tunable White

Due to the technological evolution of the electronic components, the data provided may be updated, and as such, confirmation must be requested during the order process.
Luminous flux and power supply have +/-10% tolerances with respect to the indicated value. tq +25°C (CIE 121).

We reserve the right to make technical changes.

Targetti Sankey S.r.l.
Via Pratese, 164
50145 Firenze - Italy
Tel: +39 055 37911
targetti.com
targetti@targetti.com

CCIAA Firenze
Share Capital:
€ 500.000,00
VAT N. (IT):
01537660480
R.E.A: FI-275656



1E4045DA | DART Round Maxi TW
Professional adjustable LED projector

Surge protector

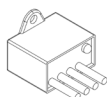

Code

A013A

Surge protector compatible with CLASS I lighting fixtures.
 Operating voltage 230-277Vac.
 SPD type 2+3.
 Max surge protection 10kV.
 CLASS I
 IP67

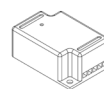

Code

A013C

Surge protector compatible with CLASS I lighting fixtures.
 DALI, DMX, 0-10V datalines compliance.
 Operating voltage 230Vac.
 SPD type 2+3.
 Max surge protection 10kV.
 CLASS I
 IP20

Due to the technological evolution of the electronic components, the data provided may be updated, and as such, confirmation must be requested during the order process.
Luminous flux and power supply have +/-10% tolerances with respect to the indicated value. tq +25°C (CIE 121).

We reserve the right to make technical changes.

Targetti Sankey S.r.l.
 Via Pratese, 164
 50145 Firenze - Italy
 Tel: +39 055 37911
 targetti.com
 targetti@targetti.com

CCIAA Firenze
 Share Capital:
 € 500.000,00
 VAT N. (IT):
 01537660480
 R.E.A: FI-275656

